

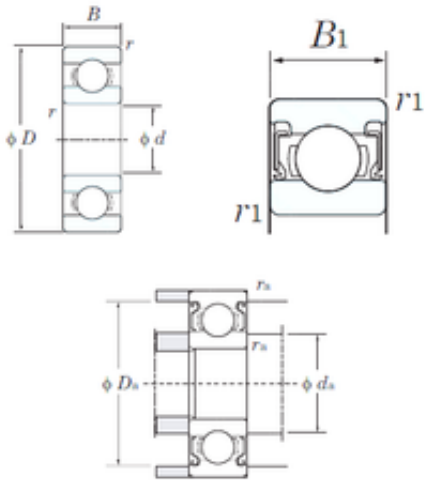

Timken BEARING MFG.CORP



6 mm x 19 mm x 6 mm KOYO 626-2RS deep groove ball bearings

Bearing No. 626-2RS

Size	6x19x6 mm
Bore Diameter	6 mm
Outer Diameter	19 mm
Width	6 mm
d	6 mm
D	19 mm
B	6 mm
C	6 mm
r min.	0,3 mm
r1 min.	0,3 mm
da min.	8 mm
Da max.	17 mm
ra max.	0,3 mm
Weight	0,0081 Kg
Basic dynamic load rating (C)	2,6 kN
Basic static load rating (C0)	1,05 kN
(Grease) Lubrication Speed	27000 r/min

626-2RS Bearing 2D drawings and 3D CAD models